

Article number: 03509110

Description: Fluro Rod end GE 110SX

Measures

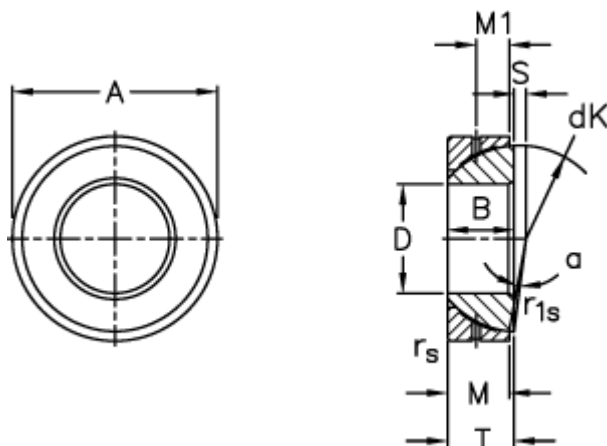

A	= 170 0 -0,025	S	= 13
B	= 38	Static load C0 (kN)	= 2360
D	= 110 0 -0,020	T	= 38 +0,25 -0,60
dK	= 155	Tilt angle	= 3
Dynamic load C (kN)	= 475	Weight	= 3680
M	= 34		
M1	= 19		
rs, r1s min	= 2		